











## QSFP-40G-ITU-2K-D

### 40Gb/s QSFP+ 2km Transceiver

#### PRODUCT FEATURES



-  4 CWDM lanes Mux/Demux design
-  Up to 11.1Gbps Data rate per wavelength
-  Up to 2km transmission on SMF
-  Electrically hot-pluggable
-  Digital Diagnostics Monitoring Interface
-  Compliant with QSFP+ MSA with LC connector
-  Case operating temperature range:0°C to 70°C
-  Power dissipation < 3.5 W

#### APPLICATIONS

-  40G Ethernet
-  Data Centre and LAN



#### STANDARD

-  Compliant to IEEE 802.3ba
-  Compliant to SFF-8436
-  RoHS Compliant.

**INDONESIA OFFICE**   
WEST PARK B-23  
JL. BLVD. BARAT BSD CITY  
PAGEDANGAN, TANGERANG  
BANTEN 15336  
 +62 2 150 858 721

**HEAD OFFICE AND R&D LAB**  
UNIT 1 / 6 POWELLS ROAD  
BROOKVALE, SYDNEY  
NSW 2100 AUSTRALIA  
 +61 2 8078 2207

**MELBOURNE OFFICE**  
11 CORPORATE DRIVE  
GRANBOURNE WEST  
VIC 3977 AUSTRALIA  
 +61 3 8679 4575

**USA R&D LAB**  
48233  
WARM SPRINGS BLVD.  
FREMONT CA  
 +1 510 945 1001  
 +1 510 298 5772

## General Description

QSFP-40G-ITU-2K-D is designed to operate over single-mode fibre system using 4X10 CWDM channel in 1310 band and links up to 2km. The module converts 4 inputs channel of 10Gb/s electrical data to 4 CWDM optical signals, and multiplexes them into a single channel for 40Gb/s optical transmission. Reverse, on the receiver side, the module optically de-multiplexes a 40Gb/s input into 4 CWDM channels signals, and converts them to 4 channel output electrical data.

The central wavelengths of the 4 CWDM channels are 1271, 1291, 1311 and 1331 nm. It contains a duplex LC connector for the optical interface and a 38-pin connector for the electrical interface. Single-mode fibre (SMF) is applied in this module. This product converts the 4-channel 10Gb/s electrical input data into CWDM optical signals (light), by a 4-wavelength Distributed Feedback Laser (DFB) array. The 4 wavelengths are multiplexed into a single 40Gb/s data, propagating out of the transmitter module via the SMF. The receiver module accepts the 40Gb/s optical signals input, and de-multiplexes it into 4 CWDM 10Gb/s channels. Each wavelength light is collected by a discrete photo diode, and then outputted as electric data after amplified by a TIA.

The product is designed with form factor, optical/electrical connection and digital diagnostic interface according to the QSFP+ Multi-Source Agreement (MSA) and compliant to IEEE 802.3ba.

### I. Absolute Maximum Ratings

Parameter	Symbol	Min.	Typ.	Max.	Unit
Storage Temperature	Ts	-40	-	85	°C
Relative Humidity	RH	5	-	95	%
Power Supply Voltage	Vcc	-0.3	-	4	V
Signal Input Voltage		Vcc-0.3	-	Vcc+0.3	V

### II. Recommended Operating Conditions

Parameter	Symbol	Min.	Typ.	Max.	Unit	Note
Case Operating Temperature	Tcase	0	-	70	°C	Without air flow
Power Supply Voltage	VCC	3.13	3.3	3.47	V	
Power Supply Current	ICC	-		900	mA	
Data Rate	BR		10.3125		Gbps	Each channel
Transmission Distance	TD		-	2	KM	
Coupled Fibre		Single mode fibre				9/125um SMF

**INDONESIA OFFICE**   
 WEST PARK B-23  
 JL. BLVD. BARAT BSD CITY  
 PAGEDANGAN, TANGERANG  
 BANTEN 15336  
 +62 2 150 858 721

**HEAD OFFICE AND R&D LAB**  
 UNIT 1 / 6 POWELLS ROAD  
 BROOKVALE, SYDNEY  
 NSW 2100 AUSTRALIA  
 +61 2 8078 2207

**MELBOURNE OFFICE**  
 11 CORPORATE DRIVE  
 GRANBOURNE WEST  
 VIC 3977 AUSTRALIA  
 +61 3 8679 4575

**USA R&D LAB**  
 48233  
 WARM SPRINGS BLVD.  
 FREMONT CA  
 +1 510 945 1001  
 +1 510 298 5772

### III. Optical Characteristics

Parameter	Symbol	Min.	Typ.	Max.	Unit	Note
<b>Transmitter</b>						
Wavelength Assignment	$\lambda_0$	1264.5	1271	1277.5	nm	
	$\lambda_1$	1284.5	1291	1297.5	nm	
	$\lambda_2$	1304.5	1311	1317.5	nm	
	$\lambda_3$	1324.5	1331	1337.5	nm	
Total Output Power	POUT			8.3	dBm	
Average Launch Power Per lane		-7		0	dBm	
Spectral Width (-20dB)	$\sigma$			1	nm	
SMSR		30			dB	
Optical Extinction Ratio	ER	3.5			dB	
Average launch Power off per lane	Poff			-30	dBm	
Transmitter and Dispersion Penalty	TDP			2.3	dB	
RIN	RIN			-128	dB/Hz	
Output Eye Mask	Compliant with IEEE 802.3ba					
<b>Receiver</b>						
Rx Sensitivity per lane (OMA)	RSENS			-11.5	dBm	1
Input Saturation Power (Overload)	Psat	0			dBm	
Receiver Reflectance	Rr			-26	dB	

Note: 1. Measured with a PRBS  $2^{31}-1$  test pattern, @10.325Gb/s, BER< $10^{-12}$ .

INDONESIA OFFICE   
 WEST PARK B-23  
 JL. BLVD. BARAT BSD CITY  
 PAGEDANGAN, TANGERANG  
 BANTEN 15336  
 +62 2 150 858 721

HEAD OFFICE AND R&D LAB  
 UNIT 1 / 6 POWELLS ROAD  
 BROOKVALE, SYDNEY  
 NSW 2100 AUSTRALIA  
 +61 2 8078 2207

MELBOURNE OFFICE  
 11 CORPORATE DRIVE  
 CRANBOURNE WEST  
 VIC 3977 AUSTRALIA  
 +61 3 8679 4575

USA R&D LAB  
 48233  
 WARM SPRINGS BLVD.  
 FREMONT CA  
 +1 510 945 1001  
 +1 510 298 5772

## IV. Electrical Characteristics

Parameter	Symbol	Min.	Typ.	Max.	Unit	Note
Supply Voltage	Vcc	3.13	3.3	3.47	V	
Supply Current	Icc			900	mA	
<b>Transmitter</b>						
Input differential impedance	Rin		100		Ω	1
Differential data input swing	Vin,pp	180		1000	mV	
Transmit Disable Voltage	VD	Vcc-1.3		Vcc	V	
Transmit Enable Voltage	VEN	Vee		Vee+ 0.8	V	2
Transmit Disable Assert Time				10	us	
<b>Receiver</b>						
Differential data output swing	Vout,pp	300		850	mV	3
Data output rise time	tr	28			ps	4
Data output fall time	tf	28			ps	4
LOS Fault	VLOS fault	Vcc-1.3		VccHOST	V	5
LOS Normal	VLOS norm	Vee		Vee+0.8	V	5
Power Supply Rejection	PSR	100			mVpp	6

### Notes:

1. Connected directly to TX data input pins. AC coupled thereafter.
2. Or open circuit.
3. Into 100 Ohms differential termination.
4. 20 – 80 %.
5. Loss of Signal is LVTTTL. Logic 0 indicates normal operation; logic 1 indicates no signal detected.
6. Receiver sensitivity is compliant with power supply sinusoidal modulation of 20 Hz to 1.5 MHz up to specified value applied through the recommended power supply filtering network

## V. Pin Assignment

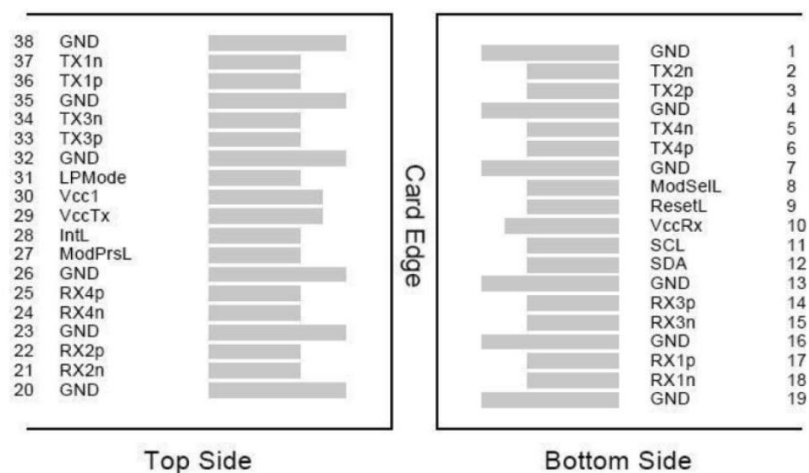

Figure 1---Pin out of Connector Block on Host Board

Pin	Symbol	Name/Description	Ref.
1	GND	Transmitter Ground (Common with Receiver Ground)	1
2	Tx2n	Transmitter Inverted Data Input	
3	Tx2p	Transmitter Non-Inverted Data output	
4	GND	Transmitter Ground (Common with Receiver Ground)	1
5	Tx4n	Transmitter Inverted Data Input	
6	Tx4p	Transmitter Non-Inverted Data output	
7	GND	Transmitter Ground (Common with Receiver Ground)	1
8	ModSelL	Module Select	
9	ResetL	Module Reset	
10	VccRx	3.3V Power Supply Receiver	2
11	SCL	2-Wire serial Interface Clock	
12	SDA	2-Wire serial Interface Data	
13	GND	Transmitter Ground (Common with Receiver Ground)	
14	Rx3p	Receiver Non-Inverted Data Output	
15	Rx3n	Receiver Inverted Data Output	
16	GND	Transmitter Ground (Common with Receiver Ground)	1
17	Rx1p	Receiver Non-Inverted Data Output	
18	Rx1n	Receiver Inverted Data Output	
19	GND	Transmitter Ground (Common with Receiver Ground)	1
20	GND	Transmitter Ground (Common with Receiver Ground)	1
21	Rx2n	Receiver Inverted Data Output	
22	Rx2p	Receiver Non-Inverted Data Output	
23	GND	Transmitter Ground (Common with Receiver Ground)	1
24	Rx4n	Receiver Inverted Data Output	1
25	Rx4p	Receiver Non-Inverted Data Output	
26	GND	Transmitter Ground (Common with Receiver Ground)	1
27	ModPrsl	Module Present	
28	IntL	Interrupt	
29	VccTx	3.3V power supply transmitter	2
30	Vcc1	3.3V power supply	2
31	LPMODE	Low Power Mode	
32	GND	Transmitter Ground (Common with Receiver Ground)	1
33	Tx3p	Transmitter Non-Inverted Data Input	
34	Tx3n	Transmitter Inverted Data Output	
35	GND	Transmitter Ground (Common with Receiver Ground)	1
36	Tx1p	Transmitter Non-Inverted Data Input	
37	Tx1n	Transmitter Inverted Data Output	
38	GND	Transmitter Ground (Common with Receiver Ground)	1

**Notes:**

1. GND is the symbol for signal and supply (power) common for QSFP+ modules. All are common within the QSFP+ module and all module voltages are referenced to this potential unless otherwise noted. Connect these directly to the host board signal common ground plane.
2. VccRx, Vcc1 and VccTx are the receiving and transmission power suppliers and shall be applied concurrently. Recommended host board power supply filtering is shown below. Vcc Rx, Vcc1 and Vcc Tx may be internally connected within the QSFP+ transceiver module in any combination. The connector pins are each rated for a maximum current of 500mA.

INDONESIA OFFICE   
 WEST PARK B-23  
 JL. BLVD. BARAT BSD CITY  
 PAGEDANGAN, TANGERANG  
 BANTEN 15336  
 +62 2 150 858 721

HEAD OFFICE AND R&D LAB  
 UNIT 1 / 6 POWELLS ROAD  
 BROOKVALE, SYDNEY  
 NSW 2100 AUSTRALIA  
 +61 2 8078 2207

MELBOURNE OFFICE  
 11 CORPORATE DRIVE  
 CRANBOURNE WEST  
 VIC 3977 AUSTRALIA  
 +61 3 8679 4575

USA R&D LAB  
 48233  
 WARM SPRINGS BLVD.  
 FREMONT CA  
 +1 510 945 1001  
 +1 510 298 5772

## VI. Digital Diagnostic Functions

Cloudtron QSFP-40G-ITU-2K-D support the 2-wire serial communication protocol as defined in the QSFP+ MSA which allows real-time access to the following operating parameters:

- ✧ Transceiver temperature
- ✧ Laser bias current
- ✧ Transmitted optical power
- ✧ Received optical power
- ✧ Transceiver supply voltage

It also provides a sophisticated system of alarm and warning flags, which may be used to alert end-users when particular operating parameters are outside of a factory-set normal range.

The operating and diagnostics information is monitored and reported by a Digital Diagnostics Transceiver Controller inside the transceiver, which is accessed through the 2-wire serial interface. When the serial protocol is activated, the serial clock signal (SCL pin) is generated by the host. The positive edge clocks data into the QSFP+ transceiver into those segments of its memory map that are not write-protected. The negative edge clocks data from the QSFP+ transceiver. The serial data signal (SDA pin) is bi-directional for serial data transfer. The host uses SDA in conjunction with SCL to mark the start and end of serial protocol activation. The memories are organized as a series of 8-bit data words that can be addressed individually or sequentially. The 2-wire serial interface provides sequential or random access to the 8 bit parameters, addressed from 00h to the maximum address of the memory.

This clause defines the Memory Map for QSFP+ transceiver used for serial ID, digital monitoring and certain control functions. The interface is mandatory for all QSFP+ devices. The memory map has been changed in order to accommodate 4 optical channels and limit the required memory space. The structure of the memory is shown in Figure 2 -QSFP+ Memory Map. The memory space is arranged into a lower, single page, address space of 128 bytes and multiple upper address space pages. This structure permits timely access to addresses in the lower page, e.g. Interrupt Flags and Monitors. Less time critical entries, e.g. serial ID information and threshold settings, are available with the Page Select function. The structure also provides address expansion by adding additional upper pages as needed. For example, in Figure 2 upper pages 01 and 02 are optional. Upper page 01 allows implementation of Application Select Table, and upper page 02 provides user read/write space. The lower page and upper pages 00 and 03 are always implemented. The interface address used is A0xh and is mainly used for time critical data like interrupt handling in order to enable a “one-time-read” for all data related to an interrupt situation. After an Interrupt, IntL, has been asserted, the host can read out the flag field to determine the effected channel and type of flag.

For more detailed information including memory map definitions, please see the QSFP+ MSA Specification.

**INDONESIA OFFICE**   
WEST PARK B-23  
JL. BLVD. BARAT BSD CITY  
PAGEDANGAN, TANGERANG  
BANTEN 15336  
 +62 2 150 858 721

**HEAD OFFICE AND R&D LAB**  
UNIT 1 / 6 POWELLS ROAD  
BROOKVALE, SYDNEY  
NSW 2100 AUSTRALIA  
 +61 2 8078 2207

**MELBOURNE OFFICE**  
11 CORPORATE DRIVE  
CRANBOURNE WEST  
VIC 3977 AUSTRALIA  
 +61 3 8679 4575

**USA R&D LAB**  
48233  
WARM SPRINGS BLVD.  
FREMONT CA  
 +1 510 945 1001  
+1 510 298 5772

2-wire serial address, 1010000x (ACh)<sup>1</sup>

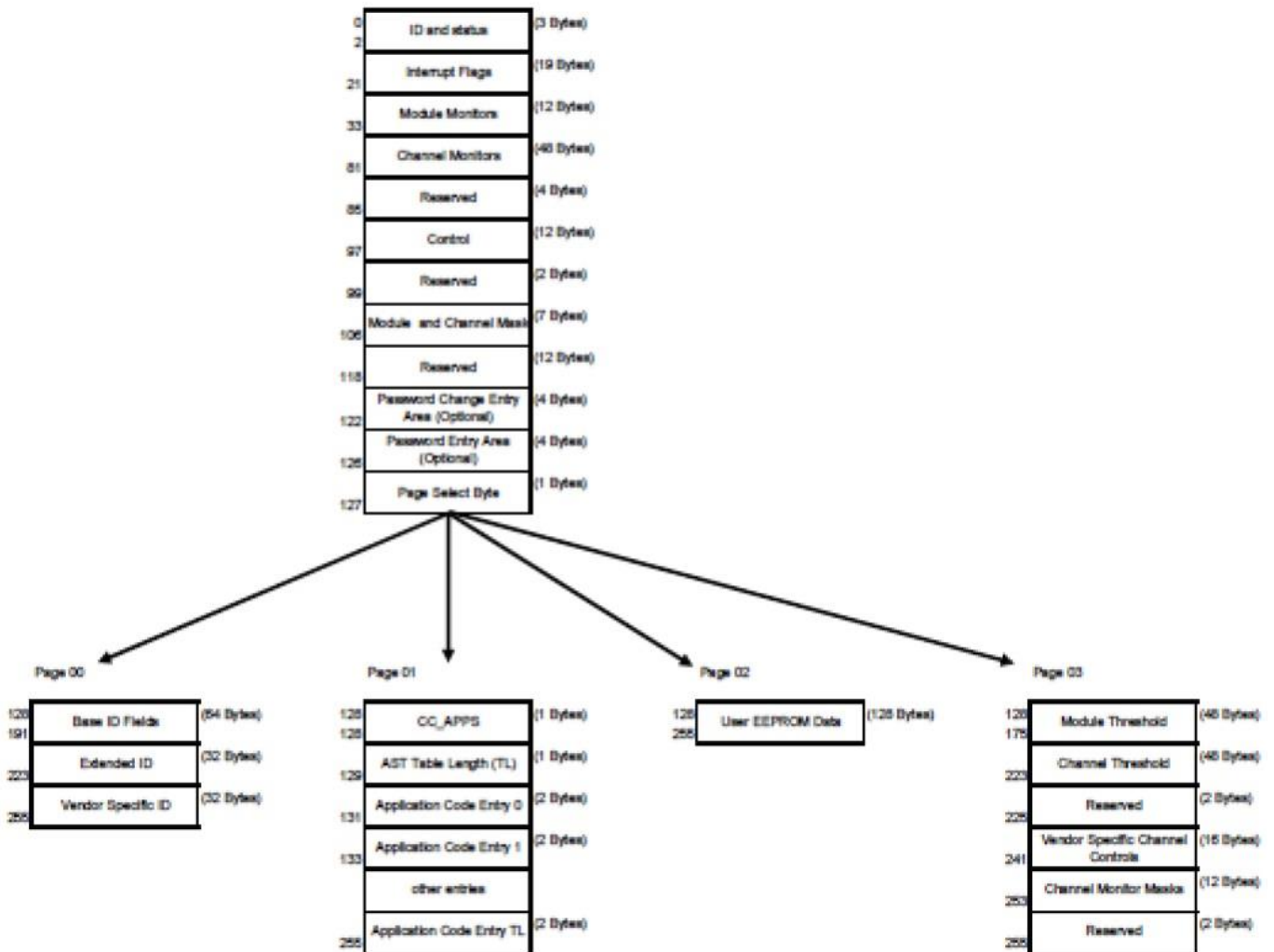

Figure 2 –QSFP+ Memory Map

## Lower Memory Map

The lower 128 bytes of the 2-wire serial bus address space, see Table 1, is used to access a variety of measurements and diagnostic functions, a set of control functions, and a means to select which of the various upper memory map pages are accessed on subsequent reads. This portion of the address space is always directly addressable and thus is chosen for monitoring and control functions that may need to be repeatedly accessed. The definition of identifier field is the same as page 00h Byte 128.

**Table 1— Lower Memory Map**

Byte Address	Description	Type
0	Identifier (1 Byte)	Read-Only
1-2	Status (2 Bytes)	Read-Only
3-21	Interrupt Flags (19 Bytes)	Read-Only
22-33	Module Monitors (12 Bytes)	Read-Only
34-81	Channel Monitors (48 Bytes)	Read-Only
82-85	Reserved (4 Bytes)	Read-Only
86-97	Control (12 Bytes)	Read/Write
98-99	Reserved (2 Bytes)	Read/Write
100-106	Module and Channel Masks (7 Bytes)	Read/Write
107-118	Reserved (12 Bytes)	Read/Write
119-122	Password Change Entry Area (optional) (4 Bytes)	Read/Write
123-126	Password Entry Area (optional) (4 Bytes)	Read/Write
127	Page Select Byte	Read/Write

## Status Indicator Bits

The Status Indicators are defined in Table 2.

**Table 2 — Status Indicators**

Byte	Bit	Name	Description
1	All	Reserved	
2	7	Reserved	
	6	Reserved	
	5	Reserved	
	4	Reserved	
	3	Reserved	
	2	Reserved	
	1	IntL	Digital state of the IntL interrupt output pin.
	0	Data_Not_Ready	Indicates transceiver has not yet achieved power up and monitor data is not ready. Bit remains high until data is ready to be read at which time the device sets the bit low.



## Interrupt Flags

A portion of the memory map (Bytes 3 through 21), form a flag field. Within this field, the status of LOS and Tx Fault as well as alarms and warnings for the various monitored items is reported. For normal operation and default state, the bits in this field have the value of 0b. For the defined conditions of LOS, Tx Fault, module and channel alarms and warnings, the appropriate bit or bits are set, value = 1b. Once asserted, the bits remained set (latched) until cleared by a read operation that includes the affected bit or reset by the ResetL pin. The Channel Status Interrupt Flags are defined in Table 3.

**Table 3 — Channel Status Interrupt Flags**

Byte	Bit	Name	Description
3	7	L-Tx4 LOS	Latched TX LOS indicator, channel 4 (Not support)
	6	L-Tx3 LOS	Latched TX LOS indicator, channel 3 (Not support)
	5	L-Tx2 LOS	Latched TX LOS indicator, channel 2 (Not support)
	4	L-Tx1 LOS	Latched TX LOS indicator, channel 1 (Not support)
	3	L-Rx4 LOS	Latched RX LOS indicator, channel 4
	2	L-Rx3 LOS	Latched RX LOS indicator, channel 3
	1	L-Rx2 LOS	Latched RX LOS indicator, channel 2
	0	L-Rx1 LOS	Latched RX LOS indicator, channel 1
4	7-4	Reserved	
	3	L-Tx4 Fault	Latched TX fault indicator, channel 4
	2	L-Tx3 Fault	Latched TX fault indicator, channel 3
	1	L-Tx2 Fault	Latched TX fault indicator, channel 2
	0	L-Tx1 Fault	Latched TX fault indicator, channel 1
5	All	Reserved	

The Module Monitor Interrupt Flags are defined in Table 4.

**Table 4 — Module Monitor Interrupt Flags**

Byte	Bit	Name	Description
6	7	L-Temp High Alarm	Latched high temperature alarm
	6	L-Temp Low Alarm	Latched low temperature alarm
	5	L-Temp High Warning	Latched high temperature warning
	4	L-Temp Low Warning	Latched low temperature warning
	3-0	Reserved	
7	7	L-Vcc High Alarm	Latched high supply voltage alarm
	6	L-Vcc Low Alarm	Latched low supply voltage alarm
	5	L-Vcc High Warning	Latched high supply voltage warning
	4	L-Vcc Low Warning	Latched low supply voltage warning
	3-0	Reserved	
8	All	Reserved	

The Channel Monitor Interrupt Flags are defined in Table 5

**Table 5 — Channel Monitor Interrupt Flags**

Byte	Bit	Name	Description
9	7	L-Rx1 Power High Alarm	Latched high RX power alarm, channel 1
	6	L-Rx1 Power Low Alarm	Latched low RX power alarm, channel 1
	5	L-Rx1 Power High Warning	Latched high RX power warning, channel 1
	4	L-Rx1 Power Low Warning	Latched low RX power warning, channel 1
	3	L-Rx2 Power High Alarm	Latched high RX power alarm, channel 2
	2	L-Rx2 Power Low Alarm	Latched low RX power alarm, channel 2
	1	L-Rx2 Power High Warning	Latched high RX power warning, channel 2
	0	L-Rx2 Power Low Warning	Latched low RX power warning, channel 2
10	7	L-Rx3 Power High Alarm	Latched high RX power alarm, channel 3
	6	L-Rx3 Power Low Alarm	Latched low RX power alarm, channel 3
	5	L-Rx3 Power High Warning	Latched high RX power warning, channel 3
	4	L-Rx3 Power Low Warning	Latched low RX power warning, channel 3
	3	L-Rx4 Power High Alarm	Latched high RX power alarm, channel 4
	2	L-Rx4 Power Low Alarm	Latched low RX power alarm, channel 4
	1	L-Rx4 Power High Warning	Latched high RX power warning, channel 4
	0	L-Rx4 Power Low Warning	Latched low RX power warning, channel 4
11	7	L-Tx1 Bias High Alarm	Latched high TX bias alarm, channel 1
	6	L-Tx1 Bias Low Alarm	Latched low TX bias alarm, channel 1
	5	L-Tx1 Bias High Warning	Latched high TX bias warning, channel 1
	4	L-Tx1 Bias Low Warning	Latched low TX bias warning, channel 1
	3	L-Tx2 Bias High Alarm	Latched high TX bias alarm, channel 2
	2	L-Tx2 Bias Low Alarm	Latched low TX bias alarm, channel 2
	1	L-Tx2 Bias High Warning	Latched high TX bias warning, channel 2
	0	L-Tx2 Bias Low Warning	Latched low TX bias warning, channel 2
12	7	L-Tx3 Bias High Alarm	Latched high TX bias alarm, channel 3
	6	L-Tx3 Bias Low Alarm	Latched low TX bias alarm, channel 3
	5	L-Tx3 Bias High Warning	Latched high TX bias warning, channel 3
	4	L-Tx3 Bias Low Warning	Latched low TX bias warning, channel 3
	3	L-Tx4 Bias High Alarm	Latched high TX bias alarm, channel 4
	2	L-Tx4 Bias Low Alarm	Latched low TX bias alarm, channel 4
	1	L-Tx4 Bias High Warning	Latched high TX bias warning, channel 4
	0	L-Tx4 Bias Low Warning	Latched low TX bias warning, channel 4
13	7	L-Tx1 Power High Alarm	Latched high TX Power alarm, channel 1
	6	L-Tx1 Power Low Alarm	Latched low TX Power alarm, channel 1
	5	L-Tx1 Power High Warning	Latched high TX Power warning, channel 1
	4	L-Tx1 Power Low Warning	Latched low TX Power warning, channel 1
	3	L-Tx2 Power High Alarm	Latched high TX Power alarm, channel 2
	2	L-Tx2 Power Low Alarm	Latched low TX Power alarm, channel 2
	1	L-Tx2 Power High Warning	Latched high TX Power warning, channel 2
	0	L-Tx2 Power Low Warning	Latched low TX Power warning, channel 2
14	7	L-Tx3 Power High Alarm	Latched high TX Power alarm, channel 3
	6	L-Tx3 Power Low Alarm	Latched low TX Power alarm, channel 3
	5	L-Tx31 Power High Warning	Latched high TX Power warning, channel 3
	4	L-Tx3 Power Low Warning	Latched low TX Power warning, channel 3
	3	L-Tx4 Power High Alarm	Latched high TX Power alarm, channel 4
	2	L-Tx4 Power Low Alarm	Latched low TX Power alarm, channel 4
	1	L-Tx4 Power High Warning	Latched high TX Power warning, channel 4
	0	L-Tx4 Power Low Warning	Latched low TX Power warning, channel 4
15-16	All	Reserved	Reserved channel monitor flags, set 4
17-18	All	Reserved	Reserved channel monitor flags, set 5
19-20	All	Reserved	Reserved channel monitor flags, set 6
21	All	Reserved	

## Module Monitors

Real time monitoring for the QSFP+ module include transceiver temperature, transceiver supply voltage, and monitoring for each transmit and receive channel. Measured parameters are reported in 16-bit data fields, i.e., two concatenated bytes. These are shown in Table 6.

**Table 6 — Module Monitoring Values**

Byte	Bit	Name	Description
22	All	Temperature MSB	Internally measured module temperature
23	All	Temperature LSB	
24-25	All	Reserved	
26	All	Supply Voltage MSB	Internally measured module supply voltage
27	All	Supply Voltage LSB	
28-33	All	Reserved	

## Channel Monitoring

Real time channel monitoring is for each transmit and receive channel and includes optical input power Tx bias current and Tx output Power. Measurements are calibrated over vendor specified operating temperature and voltage and should be interpreted as defined below. Alarm and warning threshold values should be interpreted in the same manner as real time 16-bit data. Table 7 defines the Channel Monitoring.

**Table 7 — Channel Monitoring Values**

Byte	Bit	Name	Description
34	All	Rx1 Power MSB	Internally measured RX input power, channel 1
35	All	Rx1 Power LSB	
36	All	Rx2 Power MSB	Internally measured RX input power, channel 2
37	All	Rx2 Power LSB	
38	All	Rx3 Power MSB	Internally measured RX input power, channel 3
39	All	Rx3 Power LSB	
40	All	Rx4 Power MSB	Internally measured RX input power, channel 4
41	All	Rx4 Power LSB	
42	All	Tx1 Bias MSB	Internally measured TX bias, channel 1
43	All	Tx1 Bias LSB	
44	All	Tx2 Bias MSB	Internally measured TX bias, channel 2
45	All	Tx2 Bias LSB	
46	All	Tx3 Bias MSB	Internally measured TX bias, channel 3
47	All	Tx3 Bias LSB	
48	All	Tx4 Bias MSB	Internally measured TX bias, channel 4

49	All	Tx4 Bias LSB	
50	All	Tx1 Power MSB	Internally measured TX output power, channel 1
51	All	Tx4 Power LSB	
52	All	Tx2 Power MSB	Internally measured TX output power, channel 2
53	All	Tx2 Power LSB	
54	All	Tx3 Power MSB	Internally measured TX output power, channel 3
55	All	Tx3 Power LSB	
56	All	Tx4 Power MSB	Internally measured TX output power, channel 4
57	All	Tx4 Power LSB	
58-65			Reserved channel monitor set 4
66-73			Reserved channel monitor set 5
74-81			Reserved channel monitor set 6

## Control Bytes

Control Bytes are defined in Table 8

**Table 8 — Control Bytes**

Byte	Bit	Name	Description
86	7-4	Reserved	
	3	Tx4_Disable	Read/write bit that allows software disable of transmitters.1
	2	Tx3_Disable	Read/write bit that allows software disable of transmitters.1
	1	Tx2_Disable	Read/write bit that allows software disable of transmitters.1
	0	Tx1_Disable	Read/write bit that allows software disable of transmitters.1
87	7	Rx4_Rate_Select	Software Rate Select, Rx channel 4 msb
	6	Rx4_Rate_Select	Software Rate Select, Rx channel 4 lsb
	5	Rx3_Rate_Select	Software Rate Select, Rx channel 3 msb
	4	Rx3_Rate_Select	Software Rate Select, Rx channel 3 lsb
	3	Rx2_Rate_Select	Software Rate Select, Rx channel 2 msb
	2	Rx2_Rate_Select	Software Rate Select, Rx channel 2 lsb
	1	Rx1_Rate_Select	Software Rate Select, Rx channel 1 msb
	0	Rx1_Rate_Select	Software Rate Select, Rx channel 1 lsb
88	7	Tx4_Rate_Select	Software Rate Select, Tx channel 4 msb (Not support)
	6	Tx4_Rate_Select	Software Rate Select, Tx channel 4 lsb (Not support)
	5	Tx3_Rate_Select	Software Rate Select, Tx channel 3 msb (Not support)
	4	Tx3_Rate_Select	Software Rate Select, Tx channel 3 lsb (Not support)
	3	Tx2_Rate_Select	Software Rate Select, Tx channel 2 msb (Not support)
	2	Tx2_Rate_Select	Software Rate Select, Tx channel 2 lsb (Not support)
	1	Tx1_Rate_Select	Software Rate Select, Tx channel 1 msb (Not support)
	0	Tx1_Rate_Select	Software Rate Select, Tx channel 1 lsb (Not support)
89	All	Rx4_Application_Select	Software Application Select per SFF-8079, Rx Channel 4
90	All	Rx3_Application_Select	Software Application Select per SFF-8079, Rx Channel 3

91	All	Rx2_Application_Select	Software Application Select per SFF-8079, Rx Channel 2
92	All	Rx1_Application_Select	Software Application Select per SFF-8079, Rx Channel 1
93	2-7	Reserved	
	1	Power_set	Power set to low power mode. Default 0.
	0	Power_over-ride	Override of LPMode signal setting the power mode with software.
94	All	Tx4_Application_Select	Software Application Select per SFF-8079, Tx Channel 4 (Not support)
95	All	Tx3_Application_Select	Software Application Select per SFF-8079, Tx Channel 3 (Not support)
96	All	Tx2_Application_Select	Software Application Select per SFF-8079, Tx Channel 2 (Not support)
97	All	Tx1_Application_Select	Software Application Select per SFF-8079, Tx Channel 1 (Not support)
98-99	All	Reserved	

1. Writing “1” disable the laser of the channel

## LPMode

The LPMode pin shall be pulled up to Vcc in the QSFP+ module. This function is affected by the LPMode pin and the combination of the Power\_over-ride and Power\_set software control bits (Address A0h, byte 93 bits 0,1).

The module has two modes a low power mode and a high-power mode. When the module is in a low power mode, it has a maximum power consumption of 1.5W. This protects hosts that are not capable of cooling higher power modules, should such modules be accidentally inserted. A truth table for the relevant configurations of the LPMode and the Power\_over-ride and Power\_set are shown in Table 9.

At Power up, the Power\_over-ride and Power\_set bits shall be set to 0.

**Table 9 —Power Mode Truth Table**

LP Mode	Power_Over-ride Bit	Power_set Bit	Module Power Allowed
1	0	X	Low Power
0	0	X	High Power
X	1	1	Low Power
X	1	0	High Power

## VII. Host – Transceiver Interface Block Diagram

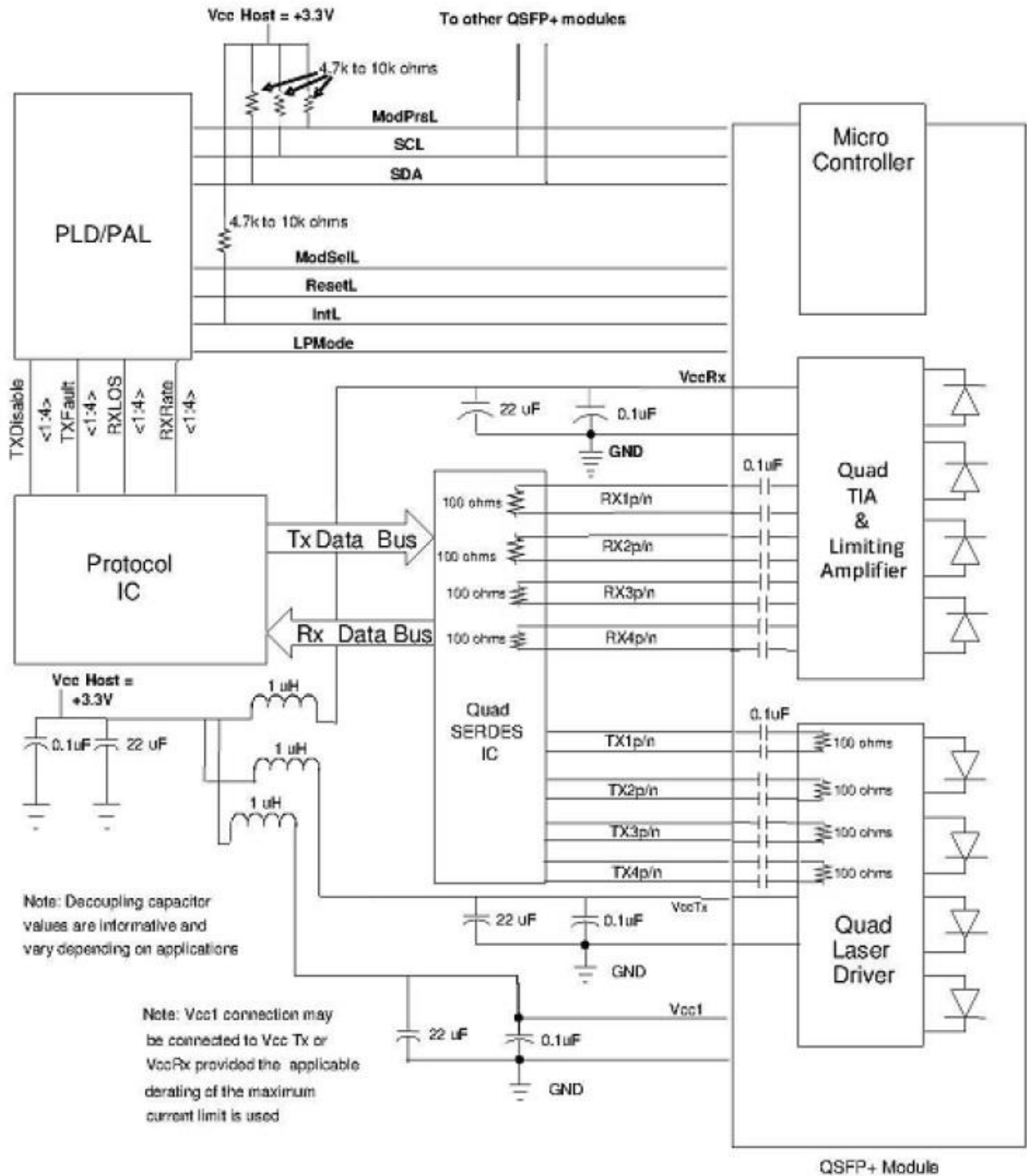

## VIII. Outline Dimension

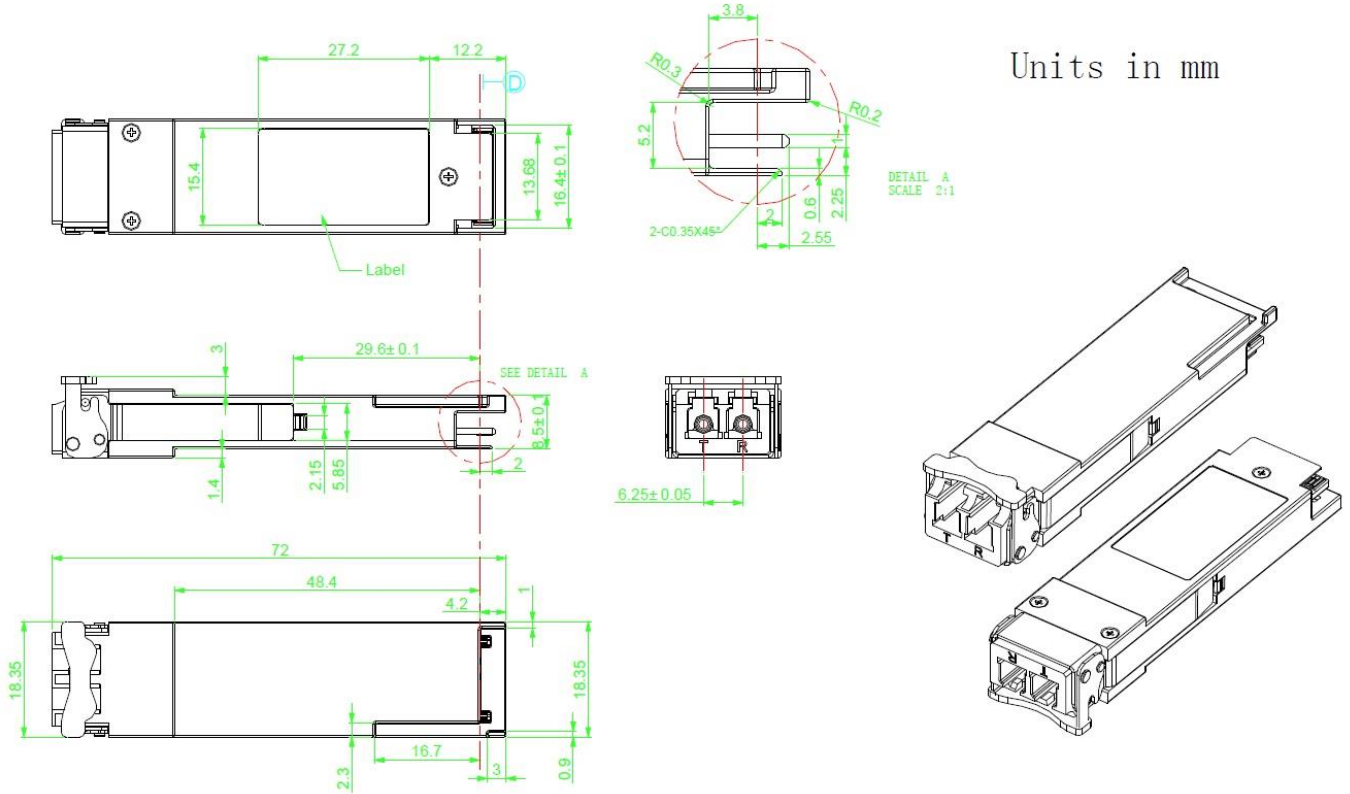

**INDONESIA OFFICE**   
 WEST PARK B-23  
 JL. BLVD. BARAT BSD CITY  
 PAGEDANGAN, TANGERANG  
 BANTEN 15336  
 +62 2 150 858 721

**HEAD OFFICE AND R&D LAB**  
 UNIT 1 / 6 POWELLS ROAD  
 BROOKVALE, SYDNEY  
 NSW 2100 AUSTRALIA  
 +61 2 8078 2207

**MELBOURNE OFFICE**  
 11 CORPORATE DRIVE  
 CRANBOURNE WEST  
 VIC 3977 AUSTRALIA  
 +61 3 8679 4575

**USA R&D LAB**  
 48233  
 WARM SPRINGS BLVD.  
 FREMONT CA  
 +1 510 945 1001  
 +1 510 298 5772